

Spin M

GEN2



KEY ADVANTAGES

- Integrates into any urban space.
- Tool-free access from the top.
- Durability and sturdiness: IP66 + IK09.
- Die Cast aluminium (Cu<0.1%).
- Energy Efficient:
GEN2: 156 lm/W
GENA: 164 lm/W
- Up to 21 photometric distributions
- Smart Ready: Designed to house both indoor and outdoor communications nodes
- Future Proof: Zhaga-compliant
- Life span L90B10 100,000h (Ta) 25°C
- Night Friendly: ULR Arrêté du 27 décembre 2018
- Optional pre- or post-installation shielding for these luminaires.
- New PLUG&PLAY connector.
- 5 years warranty



RAL 7015
Textured

SEA SIDE
SOTTABLE
Marine finish
RAL M 7015T

Dark-Sky Association certification

≤ 3.000K not available for 4.000K.

Mechanical adjustment: max. + or - 15 degrees to allow leveling in the field.

DESCRIPTION

The new generation Spin is characterised by a renewed design more elegant and aesthetic. It features a simple design with a balanced silhouette, offering a harmony between the circular shape of the body and the straight lines of the bracket.

New PLUG&PLAY connector and its tool-free opening system allow for quick and easy installation and maintenance.

Spin family is certified with IDA mark, awarded by the International Dark Sky Association, which certifies that we comply with their approval programme to provide light that protects the environment and dark skies.

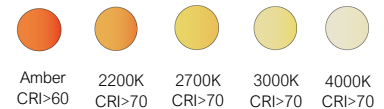

Optional CR>80



GEN2:
1.928 lm - 13.963lm
GENA:
2.383lm - 15.950m



9 Kg



GEN2: 156 lm/W
GENA: 164 lm/W



-40°C - +50°C



Tool-free
access to
control gear



0,00% - 0,08%
FHS/ULR

STANDARDS / CERTIFICATES

- CE
- RoHS
- UNE-EN 60598-1
- UNE-EN 60598-2-3 or 60598-2-5
- UNE-EN 62471:2009
- UNE-EN 60598
- UNE-EN 61000-3-2
- UNE-EN 61000-3-3
- UNE-EN 55015
- UNE-EN 61547
- UNE-EN 62031
- UNE-EN 61347-2-13
- UNE-EN 62384
- UNE-EN 13032-4
- UNE-EN ISO 9227 NSS: 2017 (1,000 h)

220 - 240 V / 100 V - 277 V
50-60 Hz
L90B10 100,000 h
Ta 25°C

*Test reports from independent ENAC accredited laboratories or equivalent. Measurements taken at ISO 17025 approved laboratory.
Meets the minimum CEI - IDAE requirements.

PHOTOMETRIC DISTRIBUTIONS

It has the 21 photometric distributions used for the environments in which this type of luminaire is installed, allows it to adapt to all needs:

GEN1

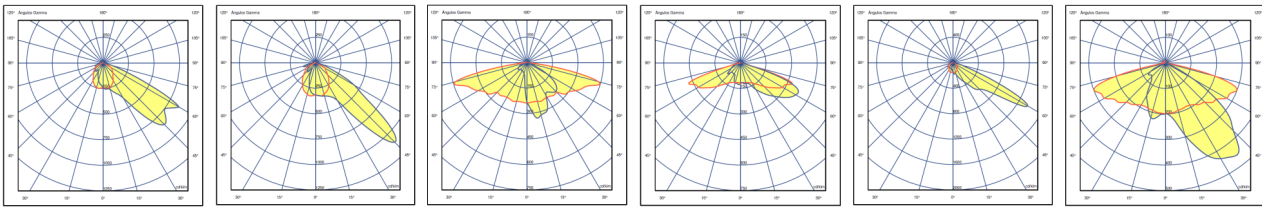

ACA1 ACM1 ALM1 AMA1 AMA2 AME2

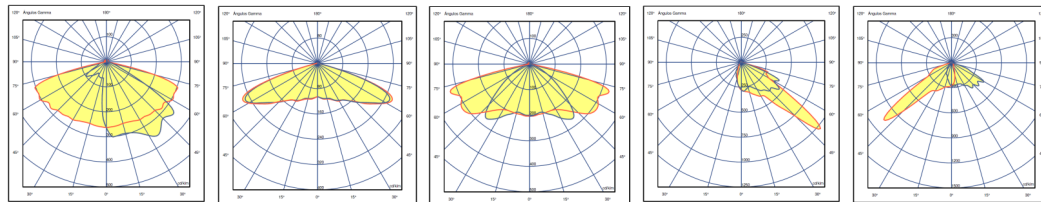

AMM1 SMA1 SME1 PCE1 PCE2

GENA

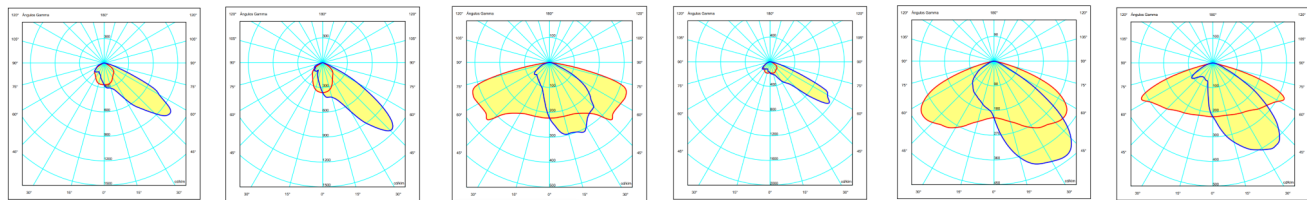

ACA1 ACM1 ALM1 AMA2 AME2 AMM1

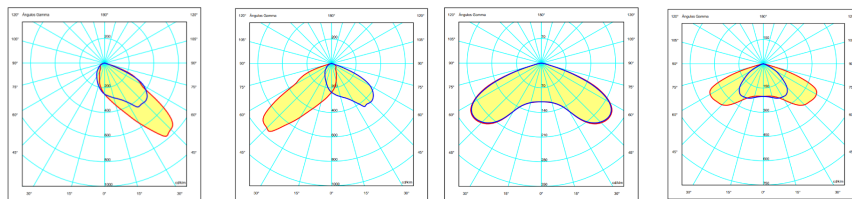

PCE1 PCE2 SMA1 SME1

APPLICATIONS

Greenways and bike lane, train and bus stations, facades and monuments, parks, squares and gardens, residential and pedestrian areas.



C. & G CARANDINI, S.A.U.
-carandini@carandini.com - www.carandini.com

SPIN

SPIN M CHARACTERISTICS

GENERAL INFORMATION

Sustainability	Valorisation: 99,29% Carbon footprint per use: 0,013727 kg kW/h de CO2
CE mark	Yes
ENEC Certificate	Yes
RoHS-compliant	Yes
Testing standards	LM 79-80 (all measurements at ISO17025 certified laboratory)

GENERAL CHARACTERISTICS

Body, Cover and Bracket	Pressure die-cast aluminium EN AC-44100 (LM6) with low copper content <0.1%. Includes a moulded silicone gasket in the perimeter channel.
Entry	M20 nickel plated brass cable gland
Light enclosure	5mm toughened flat glass.
Exterior nuts and bolts	Stainless steel (AISI304).
General ingress protection	IP66 (EN 60598-1 and EN 60529)
Level of protection against impacts	IK09 (EN 62262)
Operating temperature	Ta -40°C to +50°C According to luminaire configuration.
Lifetime	L90B10 100,000 h at Ta 25°C. Light maintenance values at 25°C. Calculated by TM-21 based on LM-80 data.

ELECTRICAL CHARACTERISTICS

Electrical class	Class I Class II
Input voltage	220 V - 240 V / 50 Hz - 60 Hz Optional 100 V- 277 V
Power factor	> 0.9 at full load.
Harmonic distortion	< 10%
Overvoltage protection	Overvoltage protection (1,2/50) 10 kV. Maximum current (8/20) 10kA. Maximum voltage (L-N) 320 V. Maximum voltage (L/N-GND) 400 V. Optional overvoltage protection: 20 kA, 20 kV.

LIGHTING CHARACTERISTICS

Package real light	GEN2: 1.928 lm - 13.963lm (21W - 103W). GENA: 2.383lm - 15.950m (17W - 103W).
LED color temperature (CRI)	4,000 K (Neutral White, nw). 3,000 K (Warm White, ww). 2,700 K (Warm White, ww). 2,200 K (Warm White, ww). Amber colour temperature, upon request.
Index of reproduction chromatic	CRI>70. CRI80 upon request
LEDs	Includes 32 and 48 LEDs.
ULR	Between 0.00% and 0.08%
Optics	PMMA polymethylmethacrylate.
Photometric distribution	ACA1: al. Long. 10° ap. trans. 40°/60° (Tipo III) ACM1: al. Long. 15° ap. trans. 45° (Tipo III) ALM1: al. Long. 75° ap. trans. 10°/45° (Tipo III) AMA1: al. Long. 70° ap. trans. 50°/65° (Tipo IV) AMA2: al. Long. 15° ap. trans. 60° (Tipo III) AME2: al. Long. 70° ap. trans. 15°/40° (Tipo II) AMM1: al. Long. 70° ap. trans. 20°/40° (Tipo II) PCE1: al. Long. 50° ap. trans. 45°/55° (Tipo IV) PCE2: al. Long. 50° ap. trans. 50°/60° (Tipo II) SMA1: al. Long. 60° ap. trans. 60° (Tipo VS) SME1: al. Long. 70° ap. trans. 40° (Tipo II)
LED thermal management	Heat dissipation via conduction, radiation and convection based on a design for LED technology.

FINISHES

Predefined luminaire colour

RAL 7015	Gray powder paint RAL 7015 Textured (7015T).
----------	--

Corrosion protection

SEASIDE SCRIBABLE	Marine Finish (1.000h)
-------------------	------------------------

SPIN S CHARACTERISTICS

MAINTENANCE AND ASSEMBLY

Installation and maintenance	Tool-free luminaire access system designed by Carandini. Access to the driver from the top.
Fixation	<p>BFO: Cast bracket (concealed hose cable outlet). BFS: Cast bracket (upper hose cable outlet). N61: Cast knot 60 (concealed hose cable outlet) PT2: Vertical fixation Ø60mm FMO: Wall fixation (concealed hose cable outlet) FMS: Wall fixation (upper hose cable outlet)</p> <p>N61, PT2, FMO and FMS fixations are supplied with BFO arm. FMS fixation is supplied with BFS arm.</p>
Accessories	<p>BMO: Horizontal steel arm 700mm. PT2-2: Vertical fixation 60 double. N60-2: Cast knot for Pole 60mm (2 luminaires). NF76-1: Cast knot for Pole 76mm (1 luminaire). NF76-2: Cast knot for Pole 76mm (2 luminaires). NF101-1: Cast knot for Pole 101mm (1 luminaire). NF101-2: Cast knot for Pole 101mm (2 luminaires) NF114-1: Cast knot for Pole 114mm (1 luminaire) NF114-2: Cast knot for Pole 114mm (2 luminaires) TS76: Top cap for Pole 76mm. TS101: Top cap for Pole 101mm. TS114: Top cap for Pole 114mm. KIT-M 12: Lampe transversale 120mm (24-48 LEDs). KIT-M 16: Lampe transversale 120mm (32 LEDs).</p>
Equipped weight	9 Kg
Pressure equalisation valve	The luminaire has a pressure equalisation valve to balance internal / external system pressure. Integrating the valve extends the projected lifetime of the gaskets and internal components by reducing the pressure exerted on them, and also prevents the entry of moisture that can cause condensation.
Cables	<p>Classe I/II Câble de 4 à 9 mètres Section transversale : 2x1,5 ; 3x1,5 ; 4x1,5 ; 5x1,5 ; 2x2,5 ; 3x2,5</p>

MANAGEMENT AND CONTROL

Equipment	<p>1N: 1 Level RC: Controller dimmed RD: DALI AF: 1 - 10 V RL: Pulse adjustable LED 2N: 2 Level SR: Smart Ready (D4i)</p>
Autonomous regulation	<p>Regulations programmed from the factory: 56: 50% from 00:00 to 06:00 66: 60% from 00:00 to 06:00 76: 70% from 00:00 to 06:00 SC: As requested by the client.</p>
CLO regulation	<p>Flow rate during the life of the product: 7: 70% luminous flux throughout the life of the luminaire. 8: 80% luminous flux throughout the life of the luminaire. 9: 90% luminous flux throughout the life of the luminaire.</p>
Socket connection	<p>3: NEMA socket on/off sin tapa U: NEMA socket on/off with IP66 cover 5: NEMA socket 5 pins without cover V: NEMA socket 5 pins with IP66 cover 7: NEMA socket 7 pins without cover W: NEMA socket 7 pins with IP66 cover 4: Base ZHAGA 4 pins without cover X: Base ZHAGA 4 pins with IP66 cover</p>
Sensor	<p>1: Photocell for base NEMA 3, 5 and 7 (20 LUX) 2: Photocell for upper ZHAGA base (20 LUX)</p>
Node	<p>ON: Controlux ONE BS: Controlux BASIC IMCU</p>

LOGISTICAL INFORMATION

SPIN M

Box size: 524x 379 x 200 mm
 Box weight: 9.0 kg.
 Number of boxes: 32 units
 American base: 1200 x 800 x 1710 mm
 Stack height: 8 levels
 Area occupied: 75%
 Volume used: 69%
 Total gross weight: 308 kg.

DIMENSIONS

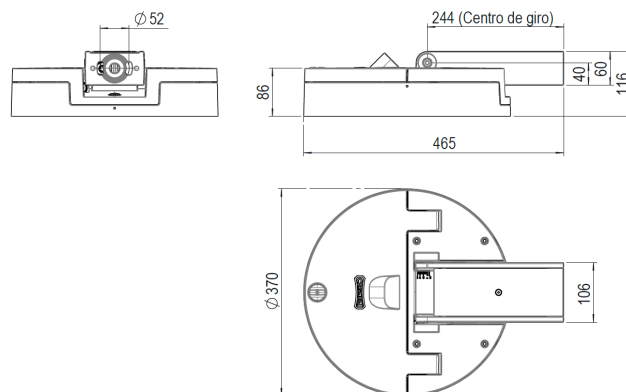
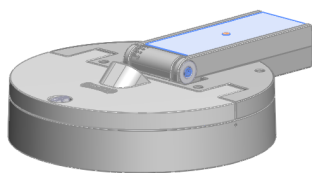

FIXATIONS

Poles Ø 60 mm

N61 (1 luminaire)

Cast knot 60 (concealed hose cable outlet)
Standard. Code: 380124

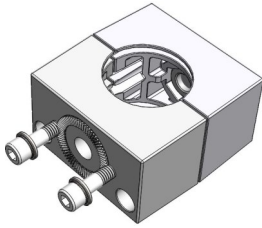

N62 (2 luminaires)

Cast knot for Pole 60mm (concealed hose cable outlet)
Accessories. Code: 380125

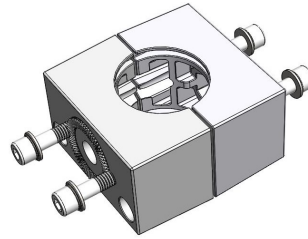

PT2 1 luminaire)

Steel coupling to steel pole the Ø60mmx100mm
(concealed hose cable outlet)
Standard. Code: 320118

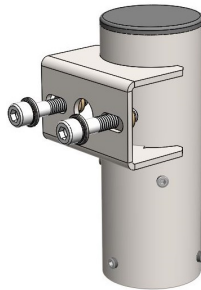

PT2 (2 luminaires)

Steel coupling to steel pole the Ø60mmx100mm
(concealed hose cable outlet)
Accessories. Code: 320141

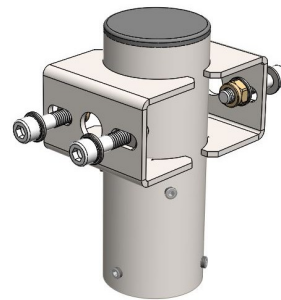

FMO

Wall fixation (concealed hose cable outlet)
Standard. Code: 380128

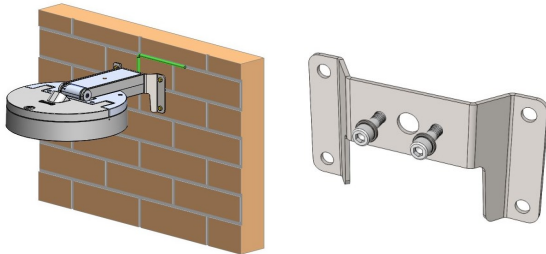

FMS

Wall fixation (upper hose cable outlet)
Standard. Code: 380127

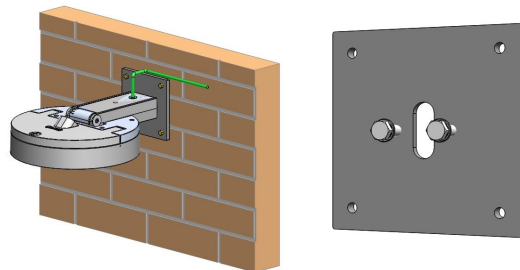

ARMS

BFO (Principal)

Cast bracket (concealed hose cable outlet)
Standard. Code: 380140

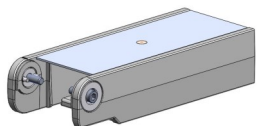

BFS

Cast bracket (upper hose cable outlet)
Standard. Code: 380080

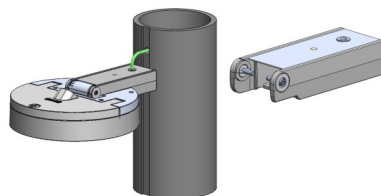

BMO

Steel Arm (concealed hose cable outlet)
Accessories. Code: 320927

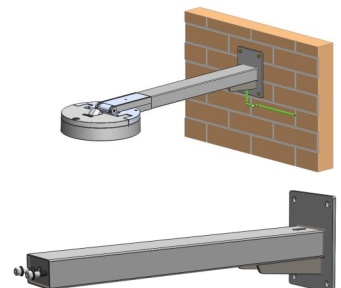

ACCESSORIES

All installation accessories are assembled with the standard fork included in the luminaire. Standard accessory colour: textured grey RAL 7015.

Accessories for Poles of Ø 76, 101 and 114 mm:

Concealed cable output

Cast knot to attach 1 luminaire

NF76-1: Knot for Pole of Ø 76 mm.
Code: 318531

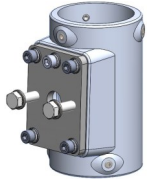

NF101-1: Knot for Pole of Ø 101 mm.
Code: 318504

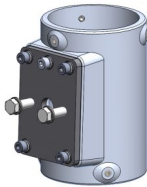

NF114-1: Knot for Pole of Ø 114 mm.
Code: 318534

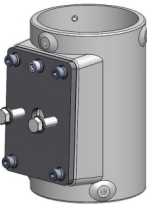

The knot includes:

To attach the knot to the Pole: M8 x 10 mm Allen studs

To attach the luminaire to the knot M16 x 50 mm screw and washers

Cast knot to attach 2 luminaires

NF76-2: Knot for Pole of Ø 76 mm.
Code: 318532

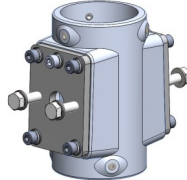

NF101-2: Knot for Pole of Ø 101 mm.
Code: 318533

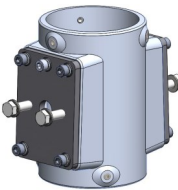

NF114-2: Knot for Pole of Ø 114 mm.
Code: 318535

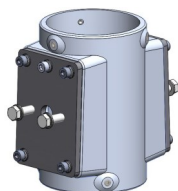

The knot includes:

To attach the knot to the Pole: M8 x 10 mm Allen studs

To attach the luminaire to the knot M16 x 50 mm screw and washers

Top cover finish cap for Pole

TS76: Top cover finish cap for Pole of Ø 76 mm.
Code: 318541

TS101: Top cover finish cap for Pole of Ø 101 mm.
Code: 318542

TS114: Top cover finish cap for Pole of Ø 114 mm.
Code: 318543

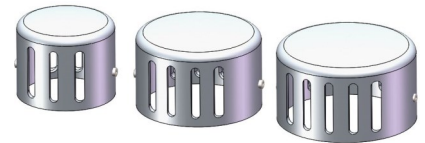

The cover finish cap includes

M8 x 10 mm Allen stud to attach to the Pole

KIT LAMA REAR -12_120mm

Accessories. Code: 380177

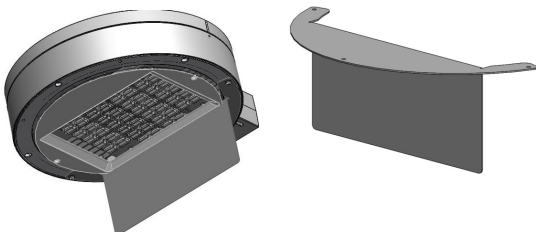

KIT LAMA REAR -16_120mm

Accessories. Code: 380178

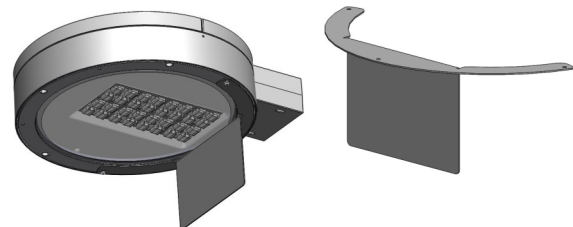

NOTE: Customisable lama according to the project by Carandini.

LUMINAIRE ADJUSTMENT

By programming the driver

Programming profile

The driver can be programmed so that luminous flux is reduced from the luminaire during the least busy hours at night while always meeting the required lighting and uniformity levels.

Programming profile 56

From 00:00 to 06:00 the luminaire reduces its initial intensity by 50%.

Up to
26%
savings

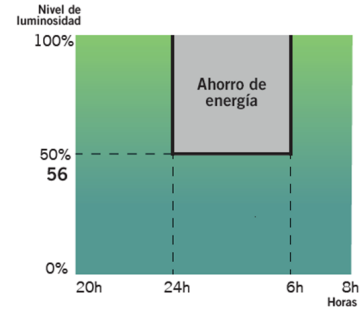

Using the CLO function

While taking lumen depreciation over the years into account, the driver is programmed so that it starts at a reduced level and gradually increases power over the lifetime of the luminaire. This saves energy and increases the lifetime of the system. Furthermore, the light level in the area where the luminaire is installed remains constant over time.

Constant luminous flux 8

Luminous flux from the luminaire at 80% to maintain light levels throughout its lifetime.

Luminous flux chart

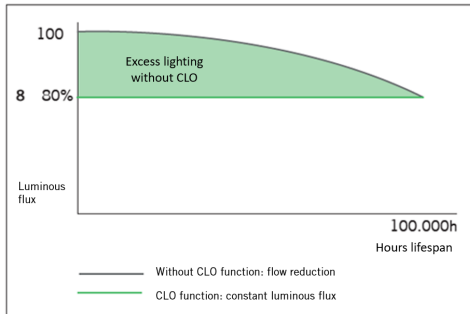

Consumption graph

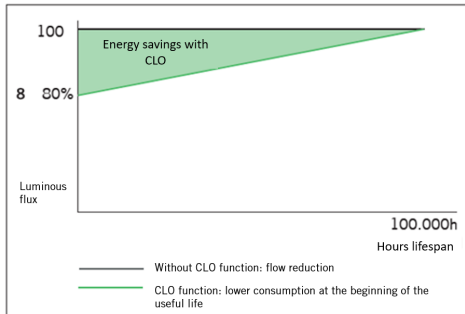

Up to
10%
savings
and increase in luminaire
service life

By incorporating an additional device

Photocell

A photocell enables the luminaire to be switched on or off based on the solar light intensity detected.

This is extremely useful so the luminaires are not switched on during the day when there is still sufficient natural light.

Ejemplo con fotocélula de 20 lx:

Si la fotocélula detecta más de 20 lx no activará el encendido de la luminaria.

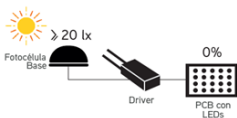

Es cuando los niveles luminicos empiezan a bajar que la fotocélula detecta 20 lx y activa el encendido de la luminaria.

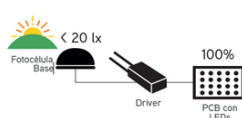

INNOVATIVE AND UPDATABLE OVER TIME (Zhaga/ ZD4i)

"All luminaires incorporating Nema Bases or Zhaga Bases, where the control system is not the responsibility of Carandini, must always incorporate IP 66 covers in order to ensure the correct safety and operation of the product.

The sale of luminaires with Nema or Zhaga Bases without the IP 66 cover will only be permitted upon receipt of a written assurance from the customer that the control system using NEMA or ZHAGA Nodes will be installed by the customer at the same time as the luminaires".

Zhaga

Zhaga - Future Proof

Zhaga is an industry-wide consortium that aims to standardise specifications for interfaces between LED luminaires and light sources. The aim is to achieve interchangeability between products made by different manufacturers. Zhaga defines test procedures for luminaire and LED light sources so that the luminaire can receive the LED source.



Zhaga D4i - Sensor Ready

The Zhaga consortium joined up with DiiA to create a unique Zhaga-D4i certification that combines Zhaga's Book 18 version 2 outdoor connectivity specifications with Dii4's D4i specifications for intra-luminaire DALI.

BOOKS PER APPLICATION. A COST-EFFECTIVE SOLUTION.

Z H A G A
Consortium

Book 1-25
Overview by application

	Office & Industry	Retail & Hospitality	Outdoor
Integrated LED light engines	14, 2,8	17, 16	
LED modules (non-integrated)	7, 21, 14	12, 9, 5, 3,10	4, 15, 19
Drivers	13	LED set 22,23	24,25
Sensor and communication modules		20	18

The specifications that mark a component as Zhaga-compliant are contained in a series of books, available only to consortium members, that allow you to design to the marked standard. The benefits for society are evident since, apart from reducing the consumption of materials, it favours the reuse of luminaires, aiming towards a circular economy.

CERTIFICATION PROGRAMME

Zhaga-D4i certification covers all the essential characteristics, including automatic adjustment, digital communication, data reporting and power requirements in any single luminaire, ensuring plug-and-play interoperability for luminaires (drivers) and peripherals, such as connectivity nodes.

STANDARDISATION AS A MEANS TO ACHIEVE SUSTAINABILITY

The Spin S luminaire has been designed to function with the latest available market-proven technology based on standards. This also enables it to meet the CARANDINI sustainability requirements and become a product ready for maintenance in the future under better guarantees while respecting the environment and society.

The luminaires marked as Zhaga are a "Future Proof" design, meaning it is based on and designed around standard Zhaga components. These components are mainly the LED modules and the drivers. The electric compartment and dissipation area for LED modules has space and additional mountings to include any driver compliant with Zhaga "Book 13" based on market driver dimensions, or any LED module compliant with Zhaga "Book 15" based on LED controller interface specifications.

This makes it possible to have a sustainable product that can be updated over time.

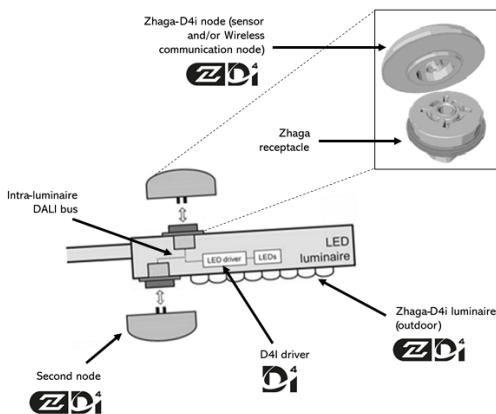

CONNECTIVITY

D4i specifications take the best of the standard DALI2 protocol and adapt it to an interconnected lighting environment, but with certain limitations. Only the control devices installed in the luminaires can be combined with a Zhaga-D4i luminaire. According to the specifications, the control devices are respectively limited to an average power consumption of 2 W and 1 W.

SMART CITY

Luminaires marked ZD4i are a "Smart Ready" design, which means they are designed to house both indoor and outdoor communication nodes through connection sockets compliant with the Zhaga "Book 18" & Zhaga-D4i standard on sensor and communication node interoperability.